

THREE PHASE SOFT COMMUTATION AUXILIARY RESONANT POLE INVERTER

V. Sládeček

VSB - Technical University Ostrava, Department of Power Electronic and Electrical Drives, 17.listopadu 15, CZ - 708 33
Ostrava - Poruba
e-mail:vaclav.sladecek@vsb.cz

Summary This paper covers the circuit modification of the power part of the inverter with auxiliary resonant poles utilising configuration of switches realised with routinely produced IGBT modules. Covered is also the control optimisation which goal is the minimisation of switching of the auxiliary resonant pole. Presented results were gained on a prototype of an inverter laboratory sample.

1. POWER PART OF AN INVERTER WITH RESONANT POLES

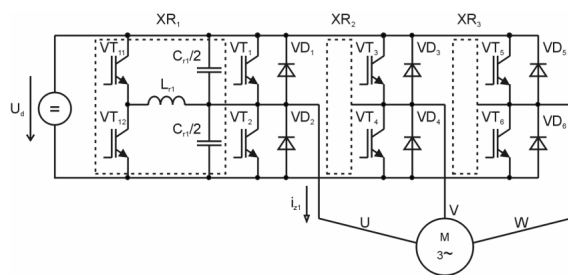

Fig. 1. Inverter with resonant poles – power part

In Fig. 1 there is shown a block scheme of the power part of used three-phase converter with soft switching. The converter with resonant poles consists of a conventional voltage source inverter with zero (reverse) diodes and resonant poles. Each branch of the inverter bridge contains switches VT11 and VT12 (VT21, VT22 and VT31, VT32). The switches activate circuits L_{r1} , $C_{r1/2}$, respective L_{r2} , $C_{r2/2}$ and L_{r3} , $C_{r3/2}$ (see fig. 1). These circuits are initialized in the instants, when the current of load is too low for fast overcharging, or wrong polarity for overcharging of resonant capacitors. If the current of load is high enough and right polarity it is possible to overcharge without resonant circuit utilization. The main switches of the converter use zero voltage switching and the auxiliary switches use zero current switching. In the case there are no losses concerning a conventional converter using hard switching.

2. DESIGN OF METHODS FOR OPTIMIZATION OF RESONANT CIRCUIT CONTROL WITH RESPECT TO LOAD CURRENT

For design of optimization of resonant circuit control it is used the scheme for one phase of resonant circuit (fig. 2). It is clear that switching of IGBT transistors has to be realised in such way to no IGBTs use hard switching. It is possible to perform optimization of switching algorithm with respect to the value of load current in the following way – to

minimal number of resonant circuit activation occurs and to short-term currents of resonant circuit have a necessary value only. The optimization can be divided into two basic problems.

- Optimization of switching algorithm of the switches in the bridge with respect to the value of I_z .
- Optimization of current impulse size in the resonant circuit with respect to the value of I_z .

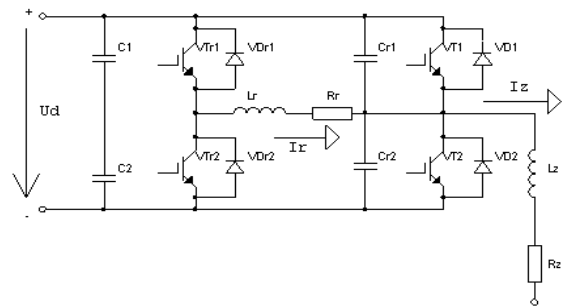

Fig. 2. One phase of quasi-resonant inverter

If the load current achieves sufficient value and right direction it is possible to overcharge the resonant capacitors by the current without resonant circuit activation. In the second case the situation is following, load current has right direction, but it is not high enough for fast overcharging the resonant capacitors. In this case the load current overcharges the resonant capacitors with the help of the resonant circuit without its activation. For right understanding it is presented detailed explanation. Each situation follows from waveforms of the load current. The first assumption – we take into account an ideal load current, we substitute it by a sinusoidal waveform. The waveform is divided into a few sectors according to size and direction of load current (see fig. 3). Current directions, positive and negative, correspond to labelling in fig. 2. The load current is also divided into sectors I, II, III with respect to its absolute value. Switching algorithm for control of one phase of quasi-resonant converter depends on the direction and sector, where load current I_z lies. From the fact follows that it exists five switching

sequences of each IGBT in the quasi-resonant bridge.

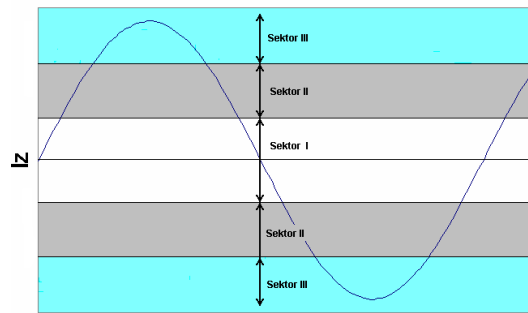

Fig. 3. Waveform of load current and its division into particular sectors

3. BLOCK SCHEME OF THE CONTROL PART FOR ONE PHASE OF THE CONVERTER USING SOFT-SWITCHING

In fig. 4, it is shown a block scheme of the control part for one phase of the converter using soft-switching. The input is a PWM signal connected to the analog part, where it is compared the load current and resonant current, it is evaluated position of load current with respect to the position in the given sector (see fig. 4) and it is chosen a switching sequence for logical part of the control circuits.

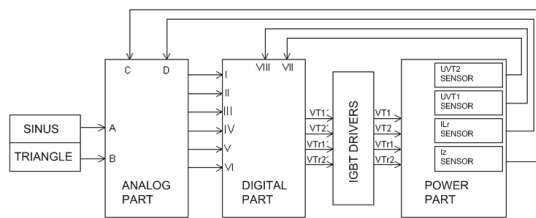

Fig. 4. Block scheme of the control part for one phase of the converter using soft-switching

Inputs and Outputs (fig.4)

- A,B Input PWM.
- C Input load current.
- D Input resonant current.

- I PWM output to digital part.
- II Load current is very large, so resonant circuit usage is not required.
- III Load current is positive and large, primary activation resonant circuit is not required.
- IV Load current is negative and large, primary activation resonant circuit is not required.

- V Resonant current is negative and sufficient to overcharge C_R .
- VI Resonant current is positive and sufficient to overcharge C_R .
- VII Voltage $U_{VT1} = 0$ (switching VT_1 is possible).
- VIII Voltage $U_{VT2} = 0$ (switching VT_2 is possible).

4. EXPERIMENTAL RESULTS

In Fig. 5 to 8 there are shown some experimental results obtained on the converter prototype using mentioned control way.

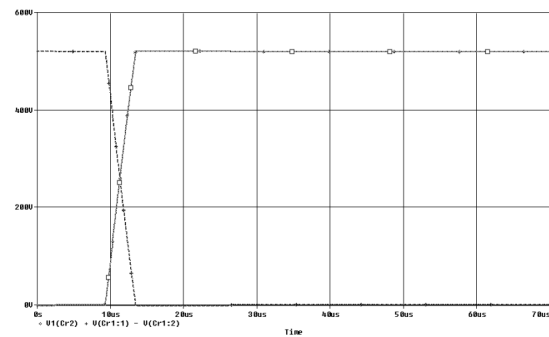

Fig. 5a. Output voltage of the resonant capacitors C_{R1} and C_{R2} (fig.2), (PSPICE simulation).

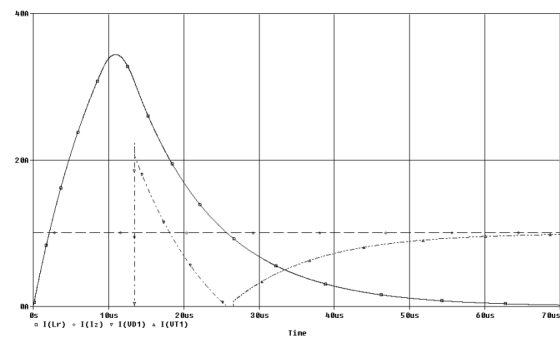

Fig. 5b. Current of the resonant circuit (fig.2), (PSPICE simulation).

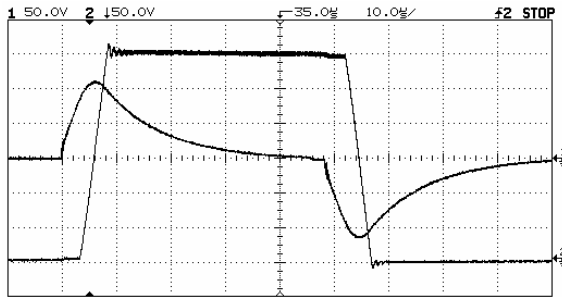

Fig. 6. Current of resonant circuit (1) and output voltage(2) of the converter prototype

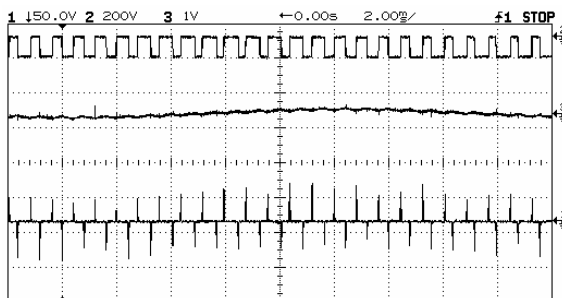

Fig. 7. Output voltage (2), current(3) and resonant current(1) for $f = 50$ Hz and small output current

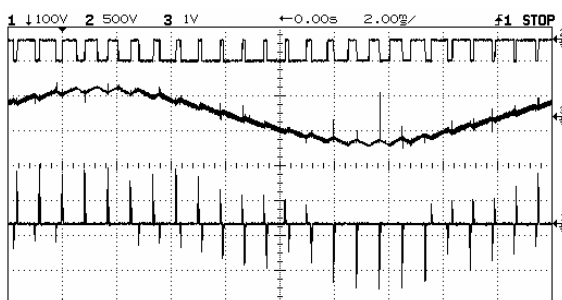

Fig. 8. Output voltage(2), current(3) and resonant current(1) for $f = 50$ Hz and large output current

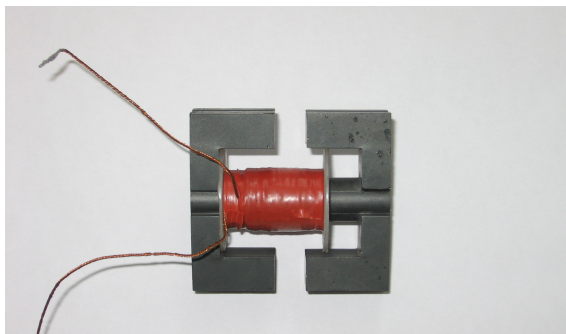

Fig.9. Resonant inductance $100\mu\text{H}$ (laboratory model)

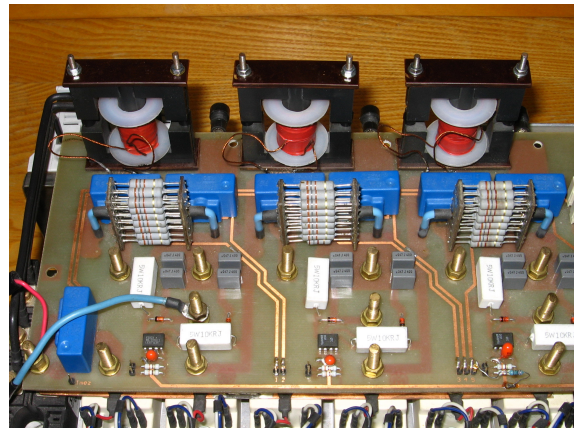

Fig.10. Frequency converter with auxiliary resonant poles – laboratory model (detail of the resonant circuits)

Acknowledgement

This work was partly financially supported by MSM: 6198910007.

REFERENCES

- [1] PENG,F.Z.,GUI-JUA SU, TOLBERT,L.,M.: A Passive Soft-Switching Snubber for PWM Inverters. In: *IEEE Transactions on Power Electronics*, VOL. 19, NO. 2, MARCH 2004
- [2] SMITH,K.,M., JR. SMEDLEY,K.,M.: A Comparison Of Voltage-Mode Soft-Switching Methods for PWM Converters. In: *IEEE Trans. Power Electronics*, March 1997, vol.12, (no.2):376-86.